

Silicon Field Stop(FS) Planar IGBT

Description

The THG40N120HQKH is use advanced field stop(FS) technology.

The 1200V FS IGBT offers superior conduction and switching performances.

General Features

- 1200V Breakdown Voltage
- Low saturation voltage: $V_{CE(sat)}$,typ=3.0V@ $I_C=40A$
- FS Planar Technology,Positive temperature coefficient
- Super High speed switch & Low power loss

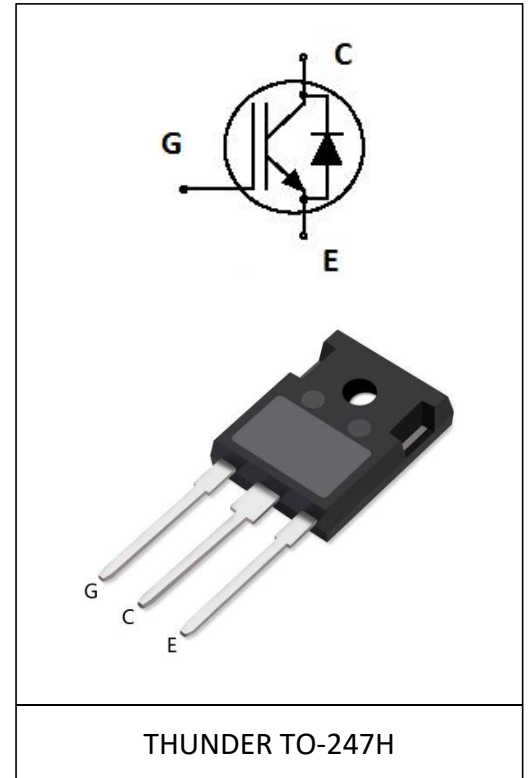

Application

- Solar Converters
- Welding Converters
- UPS

Product Summary

V_{CE}	1200V
$V_{CE(sat)}$	3.0V
I_C	40A

MAXIMUM RATINGS ($T_J = 25^\circ\text{C}$ unless otherwise noted)

Parameter	Symbol	Value	Unit	
Collector-to-Emitter Voltage	V_{CE}	1200	V	
Gate-to-Emitter Voltage	V_{GE}	± 30	V	
Collector Current	I_C	$T_C=25^\circ\text{C}$	80	A
		$T_C=100^\circ\text{C}$	40	
Power Dissipation	P_D	$T_C=25^\circ\text{C}$	625	W
		$T_C=100^\circ\text{C}$	326	

Pulsed Collector Current	$T_C=25^{\circ}\text{C}$ $t_p=10\mu\text{s}$ (Note 1)	I_{CM}	120	A
Diode Forward Current	$T_C=25^{\circ}\text{C}$	I_F	80	
	$T_C=100^{\circ}\text{C}$		40	
Pulsed Diode Forward Current	$T_C=25^{\circ}\text{C}$ $t_p=10\mu\text{s}$ (Note 1)	I_{FM}	120	
Short Circuit Withstand Time $V_{GE} = 15\text{ V}, V_{CC} = 800\text{ V}, T_C = 150^{\circ}\text{C}$		T_{SC}	10	μs
Operating Junction and Storage Temperature Range		T_J, T_{stg}	-55 T_o +175	$^{\circ}\text{C}$
Lead Temperature for Soldering Purposes		T_L	270	

THERMAL CHARACTERISTICS

Parameter	Symbol	Value	Unit
Thermal Resistance, Junction-to-Case for IGBT	R_{thJC}	0.23	$^{\circ}\text{C}/\text{W}$
Thermal Resistance, Junction-to-Ambient	R_{thJA}	62.5	

ELECTRICAL CHARACTERISTICS ($T_J = 25^{\circ}\text{C}$ unless otherwise specified)

Parameter	Symbol	Value			Unit	Test Condition
		min.	typ.	max.		

OFF CHARACTERISTICS

Collector-to-Emitter Breakdown Voltage	BV_{CES}	1200	-	-	V	$V_{GE}=0\text{ V}, I_C=1\text{ mA}$
Zero Gate Voltage Collector Current	I_{CES}	-	-	40	μA	$V_{GE}=0\text{ V}, V_{CE}=V_{CES}$
Gate-to-Emitter leakage Current	I_{GES}	-	-	± 400	nA	$V_{GE}=\pm 30\text{ V}, V_{CE}=0\text{ V}$

ON CHARACTERISTICS

Gate-to-Emitter Threshold Voltage	$V_{GE(th)}$	5.2	-	6.8	V	$V_{GE}=V_{CE}, I_C=1\text{ mA}, T_J=25^{\circ}\text{C}$
Collector-to-Emitter Saturation Voltage	$V_{CE(sat)}$	-	3.0	3.7	V	$V_{GE}=15\text{ V}, I_C=40\text{ A}, T_J=25^{\circ}\text{C}$

DYNAMIC CHARACTERISTICS

Input Capacitance	C_{IES}	-	2971	-	pF	$V_{CE} = 25\text{ V}, V_{GE} = 0\text{ V},$ $f = 1\text{ MHz}$
Output Capacitance	C_{OES}	-	251	-		
Reverse Transfer Capacitance	C_{RES}	-	73	-		
Total Gate Charge	Q_G	-	220	-	nC	$V_{CE} = 600\text{ V}, V_{GE} = 15\text{ V},$ $I_C = 40\text{ A}$

SWITCHING CHARACTERISTICS

Turn-On Delay Time	$t_{d(on)}$	-	54	-	ns	$V_{CE} = 600\text{ V}$ $V_{GE} = 0/15\text{ V}$ $I_C = 40\text{ A}$ $R_G = 30\ \Omega$ $T_J = 25^\circ\text{C}$
Turn-Off Delay Time	$t_{d(off)}$	-	111	-		
Rise time	t_r	-	33	-		
Fall time	t_f	-	105	-		
Turn-On Switching Loss	E_{on}	-	5.4	-	mJ	
Turn-Off Switching Loss	E_{off}	-	0.5	-		
Total Switching Loss	E_{ts}	-	5.9	-		

ELECTRICAL CHARACTERISTICS ($T_J = 25^\circ\text{C}$ unless otherwise specified) (continued)

Parameter	Symbol	Value			Unit	Test Condition
		min.	typ.	max.		

SWITCHING CHARACTERISTICS
DIODE CHARACTERISTICS

Diode Forward Voltage	V_F	-	2.2	3.7	-	$I_F = 40\text{ A}, T_J = 25^\circ\text{C}$
-----------------------	-------	---	-----	-----	---	---

DIODE SWITCHING CHARACTERISTICS, INDUCTIVE LOAD

Reverse Recovery Time	t_{rr}	-	36	-	ns	$V_R = 600\text{ V}, I_F = 40\text{ A},$ $dI_F/dt = 200\text{ A}/\mu\text{s}$ $T_J = 25^\circ\text{C}$
Reverse Recovery Charge	Q_{rr}	-	500	-	nC	
Reverse Recovery Energy	E_{rec}	-	0.04	-	mJ	
Peak Reverse Recovery Current	I_{RRM}	-	20	-	A	

Typical Performance Characteristics

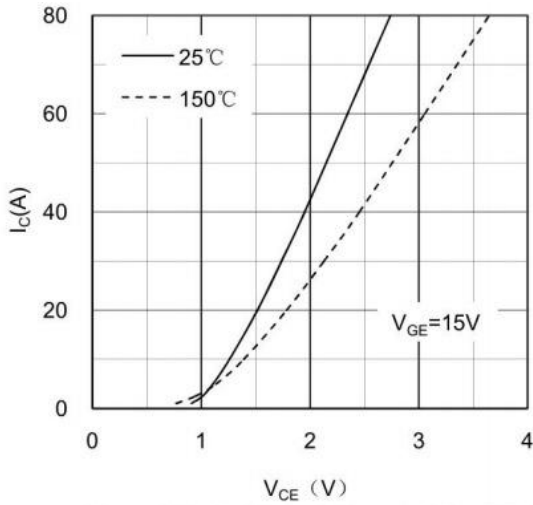

Figure 1. Typical Output Characteristics IGBT

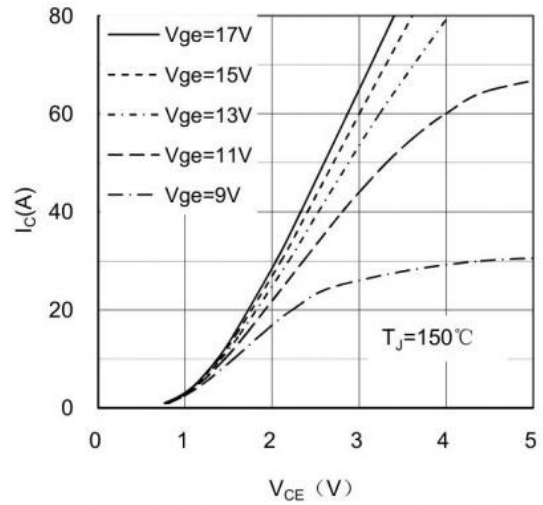

Figure 2. Typical Output Characteristics IGBT

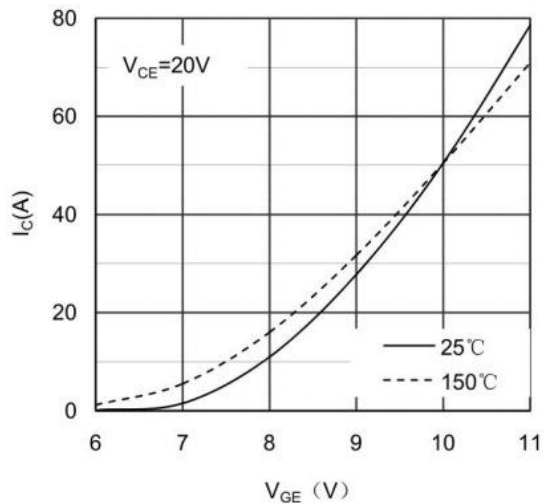

Figure 3. Typical Transfer characteristics IGBT

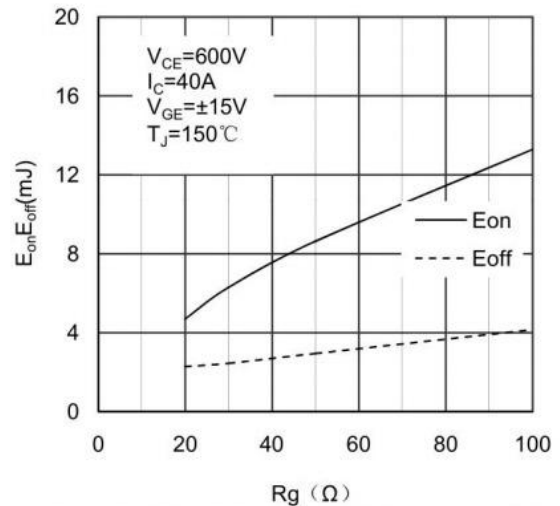

Figure 4. Switching Energy vs Gate Resistor IGBT

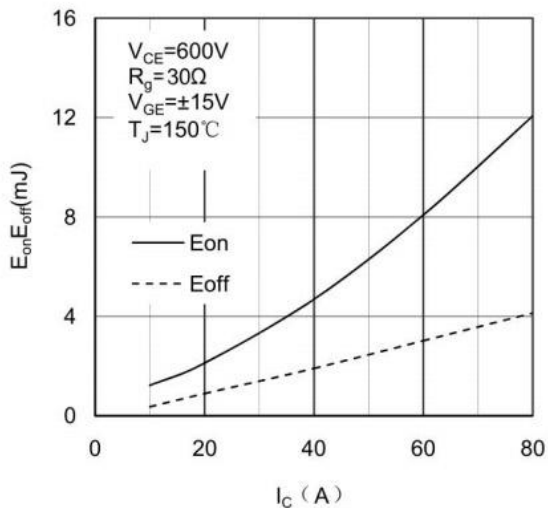

Figure 5. Switching Energy vs Collector Current IGBT

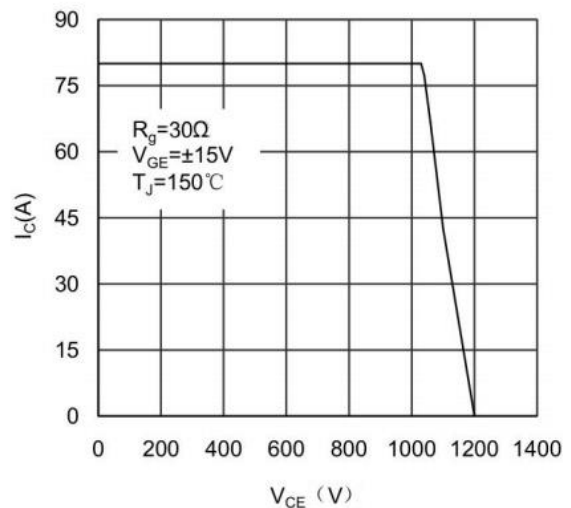

Figure 6. Reverse Biased Safe Operating Area IGBT

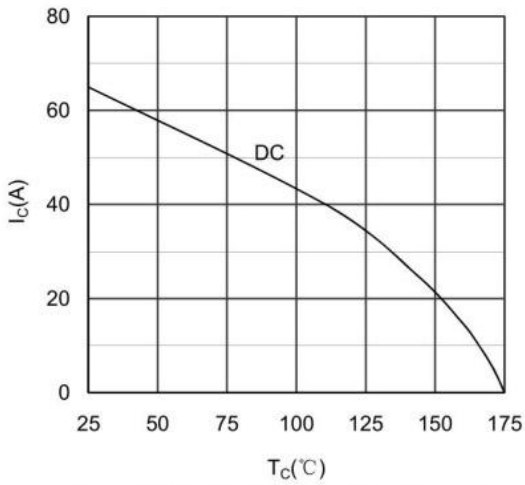

Figure 7. Collector Current vs Case temperature IGBT

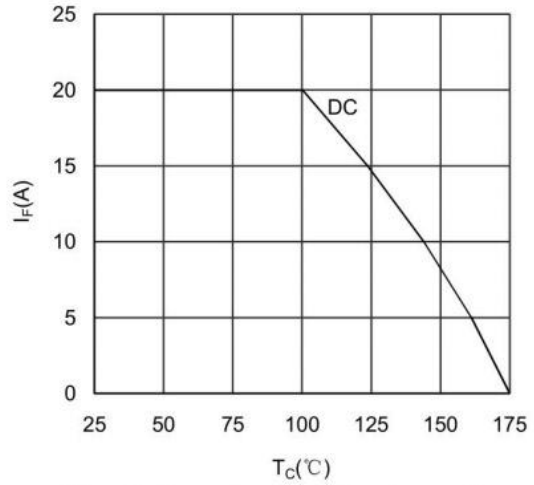

Figure 8. Forward current vs Case temperature Diode

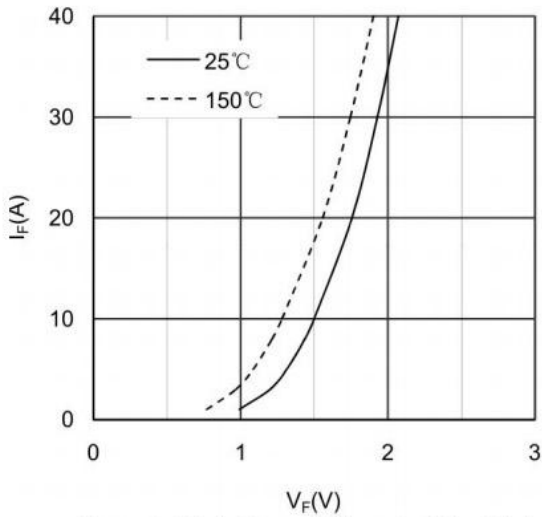

Figure 9. Diode Forward Characteristics Diode

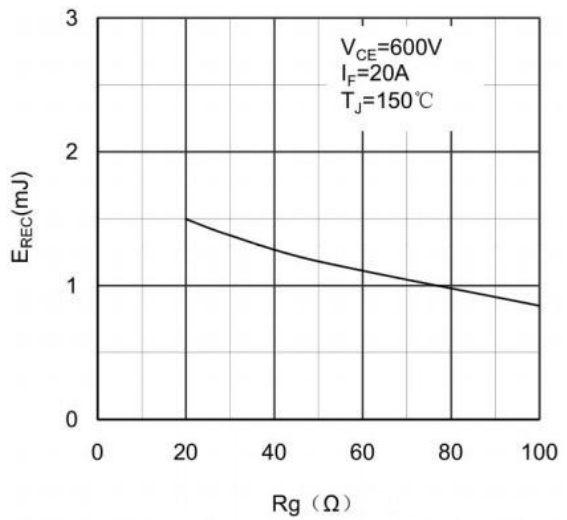

Figure 10. Switching Energy vs Gate Resistor Diode

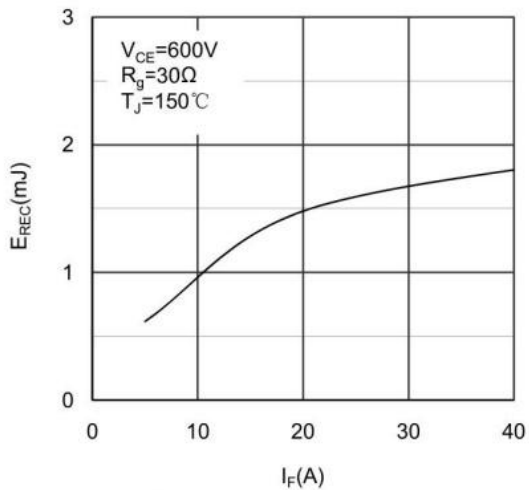

Figure 11. Switching Energy vs Forward Current Diode

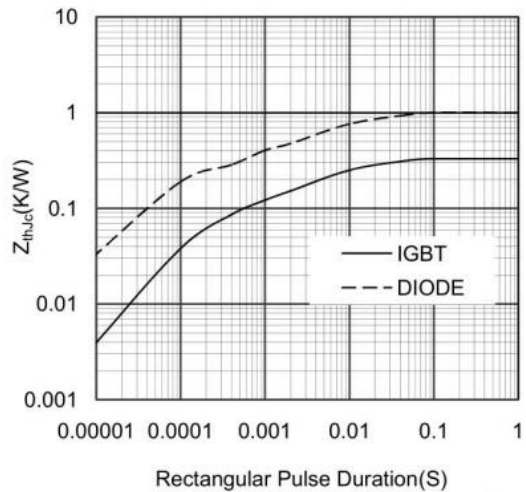
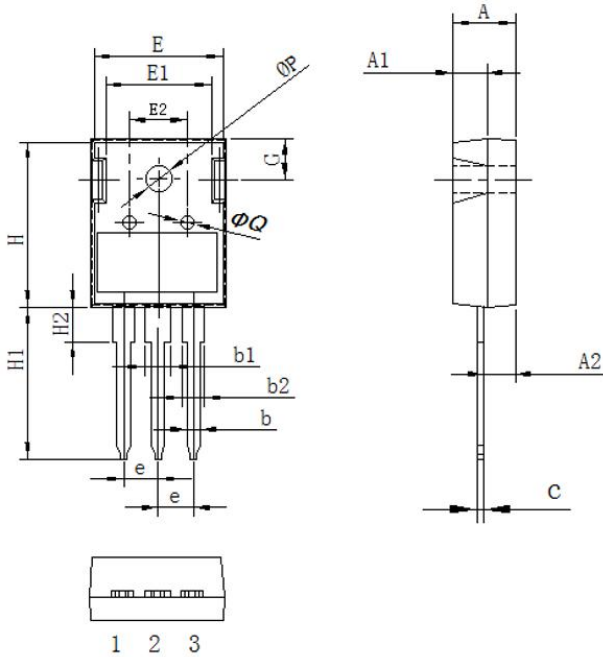

Figure 12. Transient Thermal Impedance of Diode and IGBT

Package Information
TO-247H PACKAGE
基本尺寸

Symbol	单位 mm		
	Min	Nom	Max
A	4.80	5.00	5.20
A1	2.80	3.00	3.20
A2	2.20	2.40	2.60
b	1.05	1.20	1.35
b1	2.80	3.00	3.20
b2	1.80	2.00	2.20
c	0.50	0.60	0.70
e	5.35	5.45	5.75
E	15.6	15.80	16.0
E1	12.3	12.50	12.7
E2	6.00	6.20	6.40
H	20.5	21.0	21.5
H1	19.0	20.0	21.0
H2	3.00	4.00	5.00
G	5.70	5.90	6.10
ΦP	3.30	3.50	3.50
ΦQ	2.30	2.50	2.70

Notice

Thunder Microelectronics Incorporated Limited reserves the right to make changes without further notice to any products or specifications herein. When use the product, be sure to obtain the latest specification.

Thunder Microelectronics Incorporated Limited does not assume any liability arising out of the application or any product described herein. When using Thunder Microelectronics Incorporated Limited products in your equipment, you are requested to take adequate safety measures to prevent the equipment from causing a physical injury ,fire or other problem if any of the products become faulty.

-Headquarters

WuXi Thunder Microelectronics Incorporated Limited
 Building E1-9, No.200 LingHu Road, XinWu district,WuXi,China 214135
 Tel:+86-510-85160109 Fax:+86-510-85160109