

## FRED

### Ultrafast Soft Recovery Diode, 8A

**Features:**

- Ultrafast Recovery
- 175°C operating junction temperature
- High frequency operation
- Low power loss, less RFI and EMI
- Low  $I_R$  value
- High surge capacity
- Epitaxial chip construction

Product Summary	
$V_R$	1200V
$I_{F(AV)}$	8A
$t_{rr}$	30ns

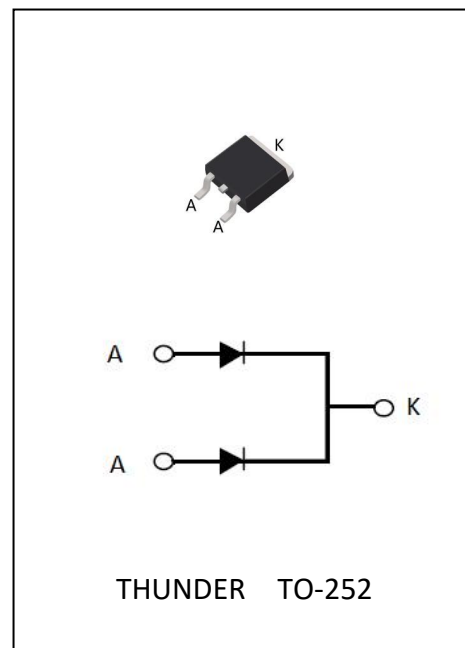

### Description/Applications

These diodes are optimized to less losses and EMI/RFI in high frequency power conditioning system. The soft recovery behavior of the diodes offers the need as snubber in most applications. These devices are ideally suited for HF welding power converters and other applications where the switching losses are not significant portion of the total losses.

### Absolute Maximum Ratings

Parameter	Symbol	Test Conditions	Values	Unit
Repetitive peak reverse voltage	$V_{RRM}$		1200	V
Continuous forward current	$I_{F(AV)}$	$T_c = 110^\circ\text{C}$	8	A
Single pulse forward current	$I_{FSM}$	$T_c = 25^\circ\text{C}$	80	
Maximum repetitive forward current	$I_{FRM}$	Square wave, 20kHz	16	
Operating junction	$T_j$		175	$^\circ\text{C}$
Storage temperatures	$T_{stg}$		-55 to +175	$^\circ\text{C}$

**Electrical characteristics (Ta=25°C unless otherwise specified)**

Parameter	Symbol	Test Conditions	Min.	Typ.	Max.	Unit
Breakdown voltage Blocking voltage	$V_{BR}$ , $V_R$	$I_R=100\mu A$	1200			V
Forward voltage (Per Diode)	$V_F$	$I_F=8A$		2.10	2.50	
		$I_F=8A, T_j=125^\circ C$		1.95	2.50	
Reverse leakage current(Per Diode)	$I_R$	$V_R=V_{RRM}$			20	$\mu A$
		$T_j=150^\circ C, V_R=1200V$			200	
Reverse recovery time(Per Diode)	$t_{rr}$	$I_F=0.5A, I_R=1A, I_{RR}=0.25A$		30	40	ns

**Thermal characteristics**

Paramter	Symbol	Typ.	Unit
$R_{\theta JC}$	Junction-to-Case	3.0	$^\circ C/W$

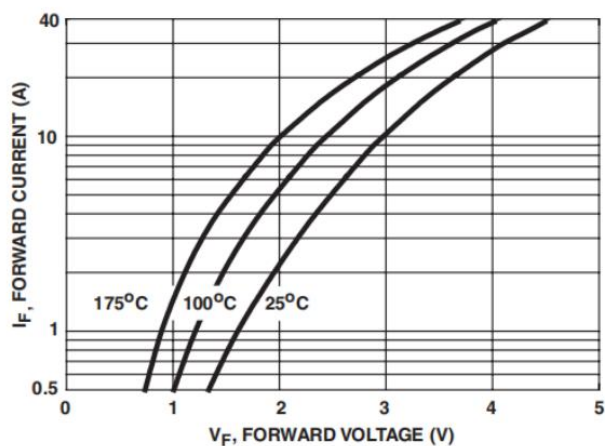
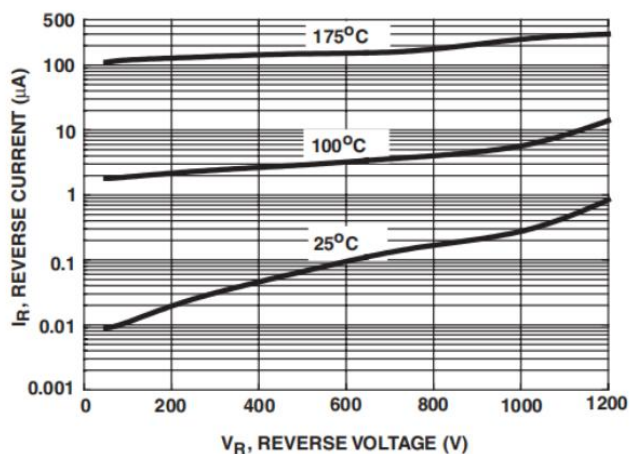
**Electrical performance (typical)**

**FIGURE 1. FORWARD CURRENT vs FORWARD VOLTAGE**

**FIGURE 2. REVERSE CURRENT vs REVERSE VOLTAGE**

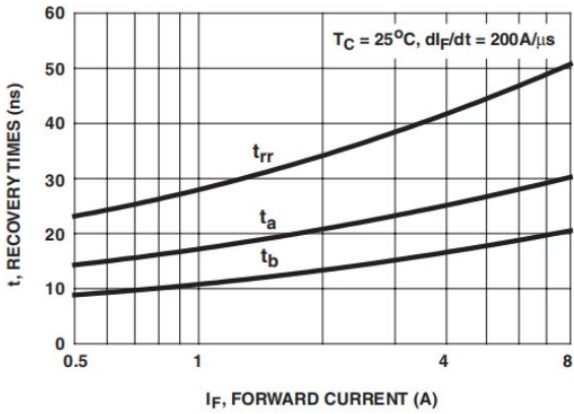

FIGURE 3.  $t_{rr}$ ,  $t_a$  AND  $t_b$  CURVES vs FORWARD CURRENT

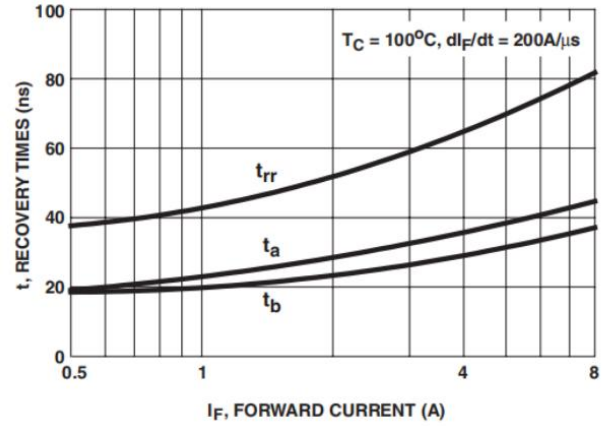

FIGURE 4.  $t_{rr}$ ,  $t_a$  AND  $t_b$  CURVES vs FORWARD CURRENT

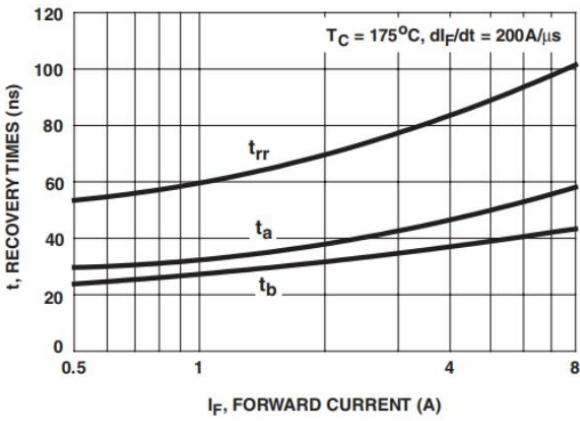

FIGURE 5.  $t_{rr}$ ,  $t_a$  AND  $t_b$  CURVES vs FORWARD CURRENT

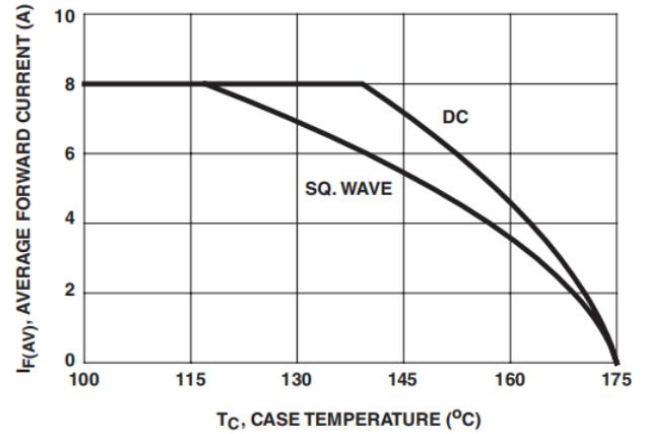

FIGURE 6. CURRENT DERATING CURVE

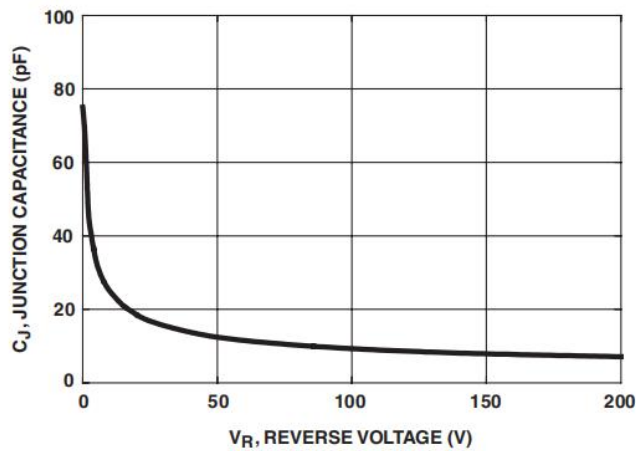
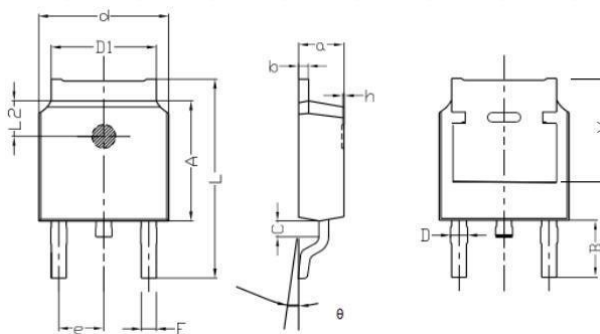

FIGURE 7. JUNCTION CAPACITANCE vs REVERSE VOLTAGE

**Package Information**
**TO-252 PACKAGE**

ITEM	SPEC (mm)	
	MIN	MAX
a	2.15	2.50
b	0.41	0.61
c	0.70	0.90
D	0.6	1.14
d	6.35	6.80
D1	5.10	5.53
A	5.40	6.40
e	2.09	2.49
L	9.25	10.41
B	2.40	3.40
L2	1.5	1.8
$\theta$	0	8
h	0	0.15
V	5.30REF	
E	0.50	0.90

**Notice**

Thunder Microelectronics Incorporated Limited reserves the right to make changes without further notice to any products or specifications herein. When use the product, be sure to obtain the latest specification.

Thunder Microelectronics Incorporated Limited does not assume any liability arising out of the application or any product described herein. When using Thunder Microelectronics Incorporated Limited products in your equipment, you are requested to take adequate safety measures to prevent the equipment from causing a physical injury ,fire or other problem if any of the products become faulty.

**-Headquarters**

WuXi Thunder Microelectronics Incorporated Limited

Building E1-9, No.200 LingHu Road, XinWu district,WuXi,China 214135

Tel:+86-510-85160109

Fax:+86-510-85160109